

# APPLICATION DATA SHEET

COPPER • BRASS • BRONZE

## brazed copper-nickel piping systems

■ Copper-nickel alloys are well known for their reliable performance in marine systems. Their corrosion resistance, antifouling properties and ability to withstand erosion-corrosion attack make these alloys ideal for use in seawater distribution piping systems. Typical shipboard and offshore platform applications include fire protection systems, sanitary plumbing services and process cooling lines.

The corrosion resistance of copper-nickel in seawater is far superior to that of a steel system, so much so that properly designed systems last the full life of a ship or platform. The principles and causes of

galvanic corrosion in mixed metal systems are well understood and can be prevented through the proper selection and application of compatible materials (Figure 1). Galvanic corrosion, between copper-nickel and other copper-based components (brass or bronze pumps, valves, fittings, etc.), does not exist when multi-materials are used for seawater piping.

Generally when a copper-nickel piping system fails the cause can be traced to misapplication of materials or improper workmanship during installation. On-site investigations indicate that five major factors contribute to faulty joints in shipboard systems:

- 1) Improper joint preparation prior to brazing,
- 2) Lack of proper support and/or hanging during the brazing procedure,
- 3) Improper heat control during brazing
- 4) Improper application of the brazing filler metal to the joint, and
- 5) Sudden shock cooling following brazing.

The installation guidelines that follow should aid those in the field charged with the responsibility of making reliable leak-free, sound, long-lasting copper-nickel brazed joints.

### MATERIAL SELECTION

In order to effectively join copper-nickel and bronze brazing fittings, a basic understanding of the differences between copper-nickel and commonly used piping materials, such as copper and steel, is necessary (Table 1).

There are a number of commercially available copper-nickel alloys, each designed with particular properties and end uses in mind. Of these, Copper Alloy No. C70600, commonly referred to as 90-10 copper-nickel, or as Alloy 706, offers the best combination of properties for marine applications. The composition of 90-10 copper-nickel, and bronze fitting alloys are shown in Table 2.

TABLE 1. COMPARISON OF MATERIALS

Material	Density, lb/cu in	Melting Range, F	Thermal Conductivity, BTU/sq ft/hr/F	Coefficient of Thermal Expansion, per F
Copper	0.323	1981	196	0.000098
Steel	0.283	2588	30	0.000067
90-10 copper-nickel	0.323	2010-2100	26	0.000095

TABLE 2. ENGINEERING DATA FOR SHIPBOARD PIPING SYSTEM MATERIALS

A. Piping Material				
Standard Designation	C70600			
Trade Name	Copper-Nickel, 10%			
Nominal Composition	88.6 Cu-10 Ni-1.4 Fe			
Military Specification	MIL-T-16420			
B. Bronze Fittings for Brazed Joints				
Standard Designations	C83600, C90300, C92200			
Trade Name	Sil-Braze Fitting			
Composition	Alloy	Cu	Sn	Pb Zn
	836	84-86	4-6	4-6 4-6
	903	86-90	5.5-6.5	1-2 3-5
	922	86-89	7.5-9	.3 3-5
Military Specification	MIL-F-1183			

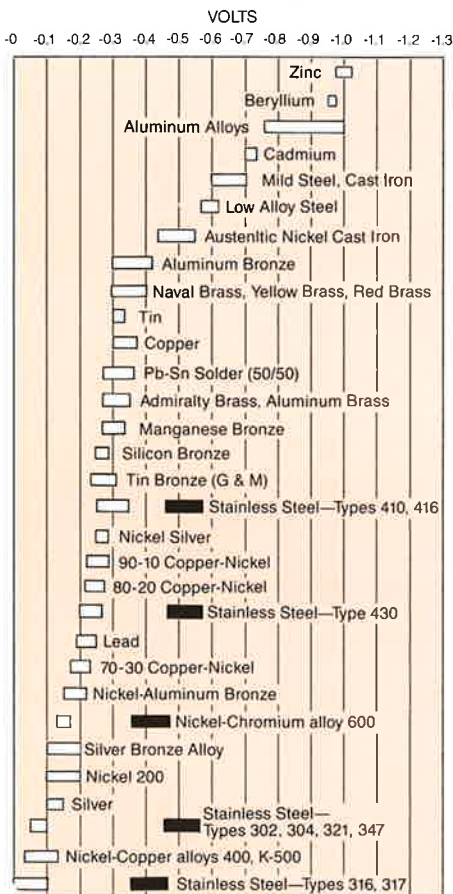

FIGURE 1. CORROSION POTENTIALS IN FLOWING SEAWATER (8-13 ft/sec; 50-80F)

■ When active due to low velocity, poor aeration.

## JOINT PREPARATION

### Measuring

Measuring the length of the pipe is not really part of the brazing job, but inaccuracy can affect joint quality. If a piece of pipe is too short it will not reach all the way into the socket of the fitting and a proper joint cannot be made (Figure 2).

### Cutting

Cutting the tube can be accomplished in several different ways to produce a satisfactory, square end cut. Copper-nickel alloys are not readily flame cut. The tube can be cut with an abrasive wheel, a carbide-tipped blade, a portable or stationary band saw, or with a multiple wheel pipe cutter (Figure 3). Allowance must be made for the fact that the alloys are relatively soft and ductile. High speed abrasive wheels work well for beveling edges and trimming material. Regardless of the cutting method used, the cut must be square with the run of the pipe so that it will seat properly in the fitting socket.

### Reaming

After cutting, the pipe must be reamed with a half-round file or other appropriate deburring tool (Figure 4). If a pipe cutter is used, the slight, rolled burr on the O.D., should be removed by filing. Failure to ream after cutting may result in eventual failure of the piping system due to erosion-corrosion at or near the unreamed pipe

ends as a result of turbulent flow caused by the burr intruding into the otherwise smooth flow of water.

### Cleaning

Following reaming, the pipe and fitting must be mechanically cleaned to remove all oxides from the surfaces to be brazed. Cleaning can be accomplished with sand or wire cloth (Figure 5) Scotch-brite® (Figure 6) or with flap-wheel abrasives and a power drill. Steel wool is not a satisfactory cleaner.

Care must be taken when cleaning not to remove excessive metal from either tube or fitting, as this could interfere with satisfactory capillary action in making the joint. Chemical cleaning may be utilized providing the pipe and fittings are thoroughly rinsed, according to the manufacturers' recommendations furnished with the chemical cleaner. Following chemical cleaning and rinsing, it is advisable to abrade the surfaces to be joined with one of the previously mentioned materials.

### Fluxing

After the surfaces have been thoroughly cleaned they should be fluxed with a light, even coating of brazing flux (Figures 7 and 8), applied with a brush to both the tube and fitting prior to assembly. The brazing flux will assist even the most inexperienced mechanic by providing a temperature indication (Figure 9) as well as a protection against overheating above 1600°F.

Most brazing fluxes, because they contain water, give off a puff of steam at



FIGURE 3. CUTTING



FIGURE 4. REAMING

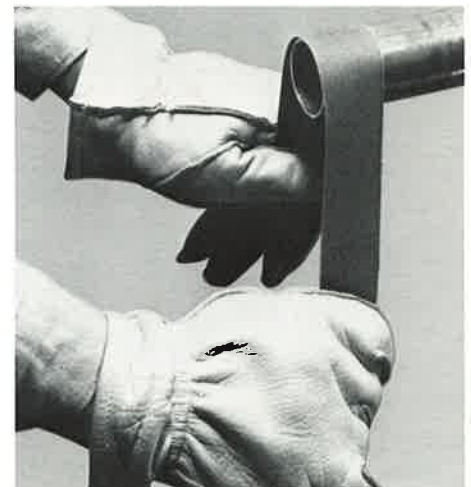

FIGURE 5. CLEANING PIPE

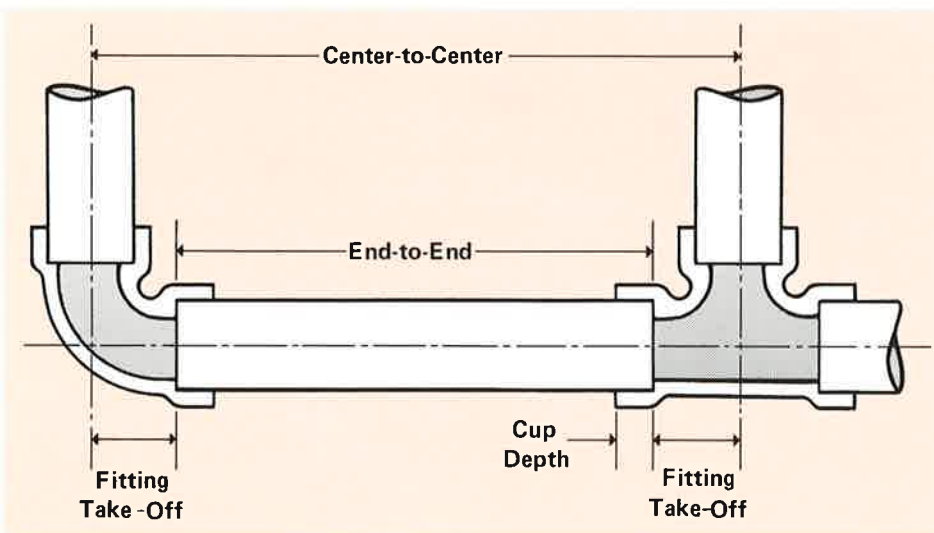

FIGURE 2. MEASURING



FIGURE 6. CLEANING FITTING



FIGURE 7. FLUXING THE PIPE



FIGURE 8. FLUXING THE FITTING

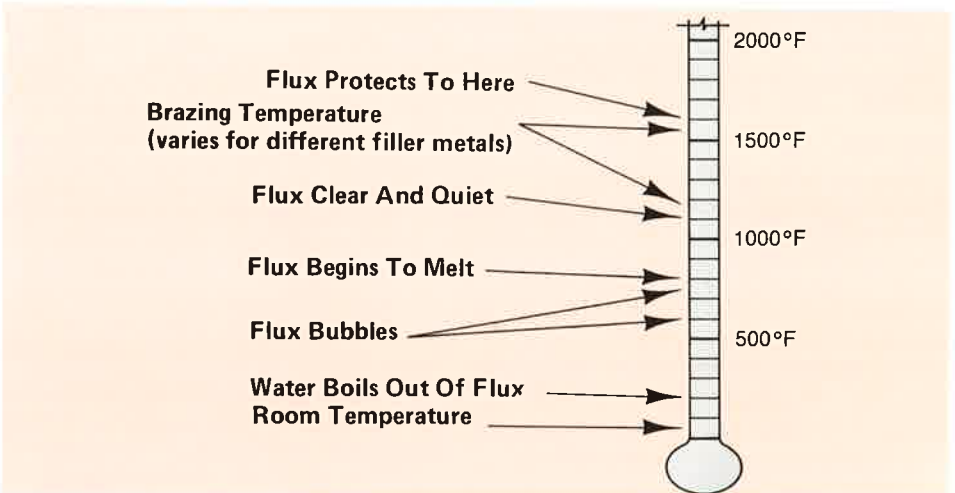

FIGURE 9. BEHAVIOR OF FLUX DURING BRAZING CYCLE

approximately 212°F. At 600°F fluxes start to dry out and take on a "popcorn" appearance. Around 800°F they start to settle down. When the flux reaches about 1100°F it becomes clear and the parts to be joined will start to become bright. This indicates the flux has started to dissolve oxides. At this point it is time to start applying the brazing metal.

### Support

Care must be taken to assure that the pipe and fittings are properly supported during assembly with a reasonably uniform capillary space around the entire circumference of the joint. This can be easily determined with an inexpensive feeler gauge. For good brazed joints, annular clearance between tube and fitting should be between .002 and .005 in. Uniformity of capillary space will ensure good filler metal penetration, when the guidelines of successful joint making just given are followed. Excessive joint clearance can cause filler metal to crack under stress or vibration.

## MAKING THE JOINT

The American Welding Society defines brazing as "a group of welding processes which produces coalescence of materials by heating them to a suitable temperature and by using a filler metal having a liquidus above 840°F (450°C) and below the solidus of the base materials. The filler metal is distributed between the closely fitted surfaces of the joint by capillary action."

A successful brazed joint depends on the following factors:

- 1) The amount of heat required to melt the filler metal,
- 2) The composition of the filler metal, and
- 3) The type of flux used.

### Brazing Filler Metals

Two basic categories of brazing filler metal are used, types BAg and BCuP (Table 3). Both are excellent for joining copper and copper alloys.

TABLE 3. BRAZING FILLER METALS—AWS A5.8/Federal QQB-654A

AWS Alloy No.	Composition						Grade
	Ag	Cu	Zn	Cd	Sn	P	
BAg—1	44-46	14-16	14-18	23-25	—	—	VII
BAg—1a	49-51	14.5-16.5	14.5-18.5	17-19	—	—	IV
BAg—2	34-36	25-27	19-23	17-19	—	—	VIII
BAg—5	44-46	29-31	23-27	—	—	—	I
BAg—18	59-61	Rem	—	—	9.5-10.5	—	—
BCuP—3	4.8-5.2	Rem	—	—	—	5.8-6.2	—
BCuP—5	14.5-15.5	Rem	—	—	—	4.8-5.2	III

For Characteristics of Brazing Filler Metals Refer to ANSI/AWS A5.8-81

**TABLE 4. BRAZING FLUXES**

AWS	Federal Spec. O-F-499c	Recommended Useful Temp. Range, F	Ingredients	Forms
3A	Type B	1050-1600	Boric Acid Borates Fluorides Fluoborates Wetting Agent	Powder Paste Liquid
3B	—	1350-2100	Boric Acid Borates Fluorides Fluoborates Wetting Agent	Powder Paste Liquid
4	Type A	1050-1600	Chlorides Fluorides Borates Wetting Agent	Powder Paste

The choice of type depends on four main factors:

- 1) Dimensional tolerance at the joint,
- 2) Type and material of fitting (cast or forged),
- 3) Desired appearance, and
- 4) Cost.

Copper-nickel alloys are most often brazed with silver-base brazing alloys (BAG types). Fillers of AWS designation BAG-1, BAG-1a, BAG-2, BAG-5 and BAG-18 are ordinarily used. Some BAG alloys contain cadmium. *There is the possibility of dangerous toxic fumes arising from cadmium bearing filler metals. To guard against any health hazards from these fumes, adequate ventilation is a necessity.*

Alloys BCuP-3 and BCuP-5 are acceptable for use with copper-nickels of 10% or less nickel content. These filler metals also have excellent flow characteristics and gap filling capabilities. They should

not be used with alloys having a high nickel content, due to the possibility that embrittling nickel phosphides will be formed. Copper-phosphorous brazing alloys should not be selected for service in sulfurous atmospheres.

**Fluxes**

When brazing a joint, the flux functions to prevent reoxidation of the cleaned surfaces and possible damage to the fitting. AWS Type 3 and Type 4 brazing fluxes are recommended when brazing copper-nickel piping systems (Table 4). These fluxes are water soluble and have the advantage of indicating the temperature of the joint during the brazing process. Avoid temperature-indicating crayons containing sulfur, which can cause local incipient cracking during torch heating.

If the system requires that no flux be left inside the pipe and fittings after brazing is completed, it is possible to apply

flux only to the pipe prior to seating it in the fitting. In this way, any excess flux is pushed back out of the joint at the fitting face and may be wiped off the exterior prior to brazing.

**Brazing**

The joint is made by proper application of heat and filler metal. First the joint should be prepared according to the principal guidelines just described, that is:

- 1) Proper measurement to insure the pipe seats fully in the fitting socket when assembled,
- 2) A square cut for seating uniformly in the fitting socket,
- 3) Complete removal of all interior and exterior burrs,
- 4) Complete cleaning of both the tube O.D. and fitting I.D. to remove surface oxides and any residual lubricants in the areas to be joined,
- 5) Proper fluxing with the correct flux, and
- 6) Proper assembly and support.

Good practice dictates that all the joints cleaned and assembled during a given work period should be brazed during that period. If allowed to stand overnight, joints should be disassembled, re-cleaned, re-fluxed, re-assembled and then brazed.

**Heating Equipment**

Oxy-acetylene, or similar equipment, using the proper tips and with a basic knowledge of the fuel gases in use (Table 5), is recommended for making brazed joints in copper-nickel piping systems.

A heating tip is recommended for brazing, not a welding tip, because of the broader and much faster heating capability of the heating tip (Figure 10).

**TABLE 5. COMPARISON OF HEAT VALUES FOR SEVERAL INDUSTRIAL GASES**

	Acetylene	MAPP <sup>(1)</sup>	Propane <sup>(2)</sup>	Propylene <sup>(3)</sup>
Flame Temperature, F	5720	5301	4579	5300
Primary Flame, BTU/cu ft	507	517	295	403
Secondary Flame, BTU/cu ft	963	1889	2268	1969
Total Heat, BTU/cu ft	1470	2406	2563	2372

<sup>(1)</sup>MAPP gas is a trademark of AIRCO Inc. It is methylacetylene and propadiene stabilized.

<sup>(2)</sup>Gases with propane base plus liquid hydrocarbon additives have similar heat values to propane, but vary with the amount and type of additives. These include ACETOGEN, FLAMEX, INTENSAFLAME and VOCTORGAS.

<sup>(3)</sup>Propylene based gases include APACHI, B PLUS, GO GAS, HIGH PURITY GAS, NCG T-9, PRESTO-LENE, RD and UCON 96.

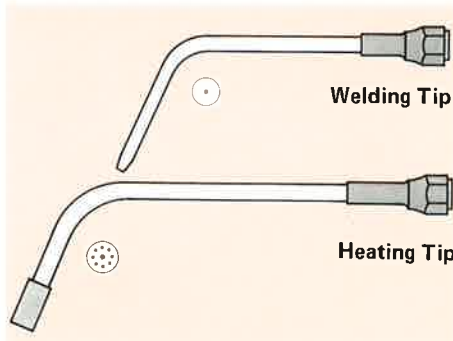

**FIGURE 10. OXY-FUEL TIPS**

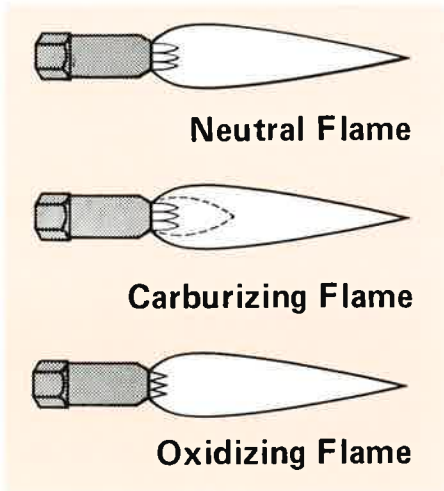

FIGURE 11. OXY-FUEL FLAMES

A neutral flame, one which uses equal parts of fuel and oxygen from the cylinders, is best (Figure 11).

### Heating Technique

Heating should be done in the following manner:

- 1) With the flame perpendicular to the pipe wall, pre-heat the tube to conduct the heat into the socket of the fitting so that heating of the joint (pipe and fitting) begins from the inside out (Figure 12). While pre-heating should not take much more than a minute (depending on size of pipe and fitting), experience will indicate the proper time.

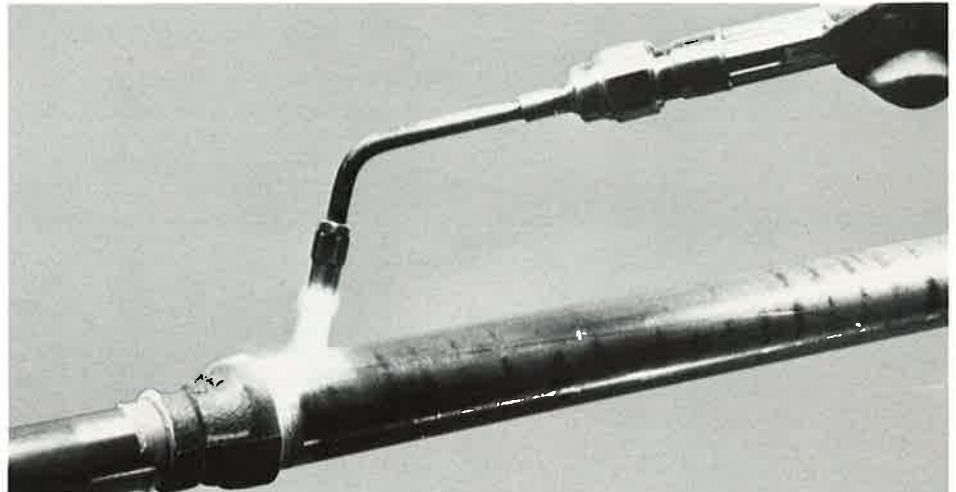

FIGURE 12. PRE-HEATING PIPE

- 2) Once the pipe is pre-heated, the flame should be moved onto the fitting (Figure 13) moving from fitting to tube about a distance equal to the depth of the fitting socket. This completes pre-heating of the joint and if flux is used, the clear, quiet stage of the flux will indicate temperature in the 1100°F range.
- 3) The heat should now be concentrated at one point on the joint, with the torch still heating both pipe and fitting. Once the joint has reached the proper temperature and the filler metal begins melting at the face of the fitting, apply it steadily to the joint while following the torch around the fitting (Figure 14). Continue this

- technique to the point of beginning and overlap the joint slightly.
- 4) If the application of the brazing filler metal is slightly behind the torch, a well-developed fillet will form at the face of the fitting. If the torch is behind the application point of the filler metal, the fillet will generally be lost and an additional pass must be made to renew the fillet.

In a horizontal position, the starting point should be slightly off-center of the bottom of the joint. The mechanic should proceed across the bottom of the fitting and up to the top-center position and then return to the point of beginning, lap the starting point of the joint with the filler

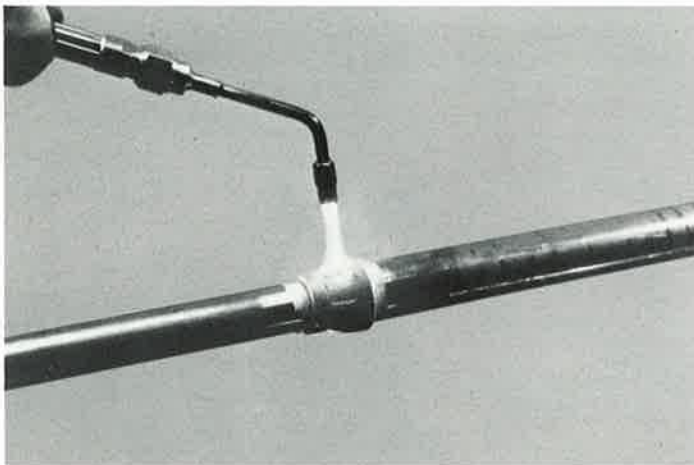

FIGURE 13. PRE-HEATING JOINT

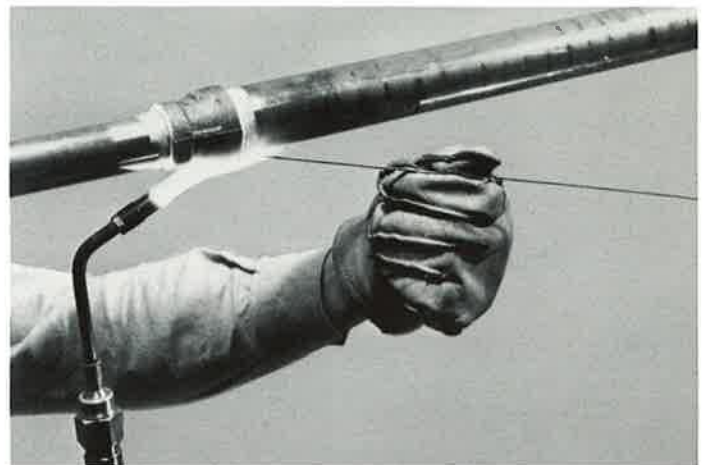

FIGURE 14. APPLICATION OF FILLER METAL

metal, and then proceed up the incomplete side of the joint to the top, again overlapping the joint at the top-center position.

### Cooling

After the joint has been completed, natural cooling is best. Shock cooling may result in cracked fittings or stress cracking of the brazing alloy. Any flux residues should be removed after cooling by washing with hot water and brushing with a stainless steel wire brush.

---

## REPAIR

Repairing brazed joints requires careful evaluation of each joint in question. Most leaks are the result of incorrect brazing technique. If the system can be shut down and drained, two alternatives should be considered:

- 1) Complete replacement of the faulty joint, or
- 2) Dismantling of joints with oxy-fuel equipment, removal of as much existing brazing alloy and corrosion deposit as possible and remaking of the joint according to the steps recommended above.

If a system shutdown is not possible, short-term isolation of the faulty joint can be accomplished with commercially available pipe freezing equipment. When the joint is isolated, any residual moisture can

be removed by heating the joint with a torch. The steam will escape through the leaking joint. The joint can then be either:

- 1) Taken apart and brazed properly, or
- 2) Brazed again using a BCuP brazing filler metal (this takes advantage of the self-fluxing characteristics of the phosphorous-bearing alloys), or
- 3) Temporarily repaired (for pinhole leaks) by soldering, using an appropriate soldering flux and a tin-silver solder.

---

## TESTING AND INSPECTION

### Visual

The inspection and testing of brazed joints can be accomplished in a number of different ways. Destructive testing is used during the brazing training process. Joints that have been brazed can be cut lengthwise into a specified number of segments (depending on the joint diameter) and visually inspected (Figure 15).

This normally requires polishing of the joint surfaces and viewing with a hand-held magnifying glass. Visual inspection is useful for checking:

- 1) Dimensional accuracy of the brazed joint,
- 2) Conformity to specified brazing procedure,
- 3) Acceptability of braze appearance with regard to cleanliness, and

- 4) Presence of surface flaws such as cracks and incomplete penetration at joint interface.

Although visual inspection is invaluable, it is unreliable for detecting subsurface flaws. Good judgement on the part of the inspector must be relied upon.

### Radiography

Radiography, using X-ray or gamma radiation, can be used to examine the interior of the braze. This type of non-destructive test provides a permanent record of the joints, but is slow and expensive. Radiography enables the inspector to locate subsurface defects such as inclusions, cracks, porosity and voids in the brazed joint.

### Ultrasonic

Ultrasonic inspection, sometimes referred to as UT, is a non-destructive method of analyzing brazed joints for internal quality. A series of recent tests verifies UT as an effective method for inspecting brazed joints. Reliability and competency of the operator are essential. The extremes of good and bad joints are discernible, but the choice between marginally good or marginally bad joints depends on the interpretation of the operator.

---

## SUMMARY

Copper-nickel seawater piping systems, when engineered and installed properly, will provide years of safe and reliable service. Proper training in the correct installation techniques, as outlined herein, will give the mechanic the ability to achieve consistently reliable brazed joints.

*This publication has been prepared for the use of journeymen and pipe fitting contractors involved in the installation or repair of small diameter seawater distribution piping systems. The guidelines compiled by CDA describe accepted industry practices. CDA assumes no responsibility or liability of any kind in connection with this publication, and makes no warranties of any kind with respect to the information contained herein.*

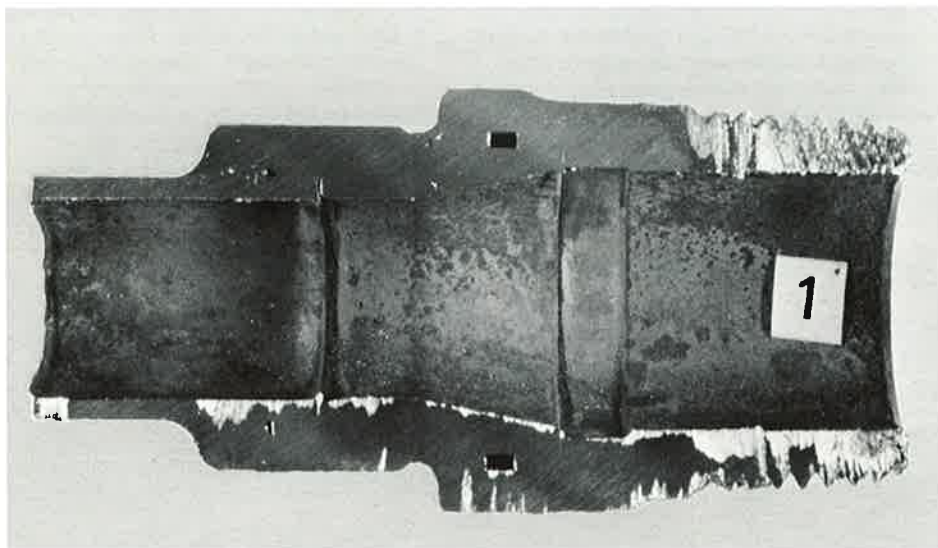

FIGURE 15. VISUAL INSPECTION